



▶ CUMULATIVE RESULTS SUMMARY 1

▶ DEN NOISE HOTLINE POLICY..... 3

▶ JANUARY - DECEMBER RESULTS 5-9

DEN Noise *report*

JANUARY 1, 2011 THROUGH DECEMBER 31, 2011

Cumulative Results for the Period January 1, 2011 through December 31, 2011

The number of potential Class II NEPS violations registered between January 1 through December 31, 2011 was one. There was one potential Class II NEPS violation during the same period the previous year. Please see pages 4 and 6 for Denver International Airport (DEN) NEPS information. There was no potential 65 DNL noise contour violation for either time period, as the 65 DNL contour continued to be completely contained within the boundaries of the City and County of Denver (CCD). Please see page 5 for DEN contour map.

The number of households registering at least one complaint increased only slightly from the year before from 51 in 2010 to 52 in 2011. Five households registered a combined 87.5 percent of total complaints in 2011. The number of complaints decreased by 27 complaints during 2011 as compared to the same period in 2010 (2,293 vs. 2,320 in 2010).

The percentage of complaints increased in 2011 for nighttime aircraft operations (10 p.m. to 7 a.m.) to 13.5 percent of total complaints received compared to 12.3 percent in 2010. Please see pages 7 and 8 for complete complaint and operational data.

To access the DEN Noise Report for the first three quarters of 2011, please go to: <http://business.flydenver.com/community/noise/index.asp>.



DEN Airport Noise and Operations Monitoring System



Remote Monitoring Terminal (RMT) with a weather collecting station.

The DEN Airport Noise and Operations Monitoring System (ANOMS) is a state-of-the-art computer system designed to enable the City and County of Denver to monitor aircraft noise in the vicinity of the airport. In addition to monitoring noise levels, the system calculates Noise Exposure Performance Standards (NEPS) at 101 grid points in Adams County (see map on page 4 for NEPS locations).

The DEN ANOMS system monitors noise levels at 27 permanent and four portable noise monitoring terminals. These terminals are located throughout the Denver metro area (see map on page 4 for RMT locations).

The system also records the movement of all aircraft in the vicinity of DEN by utilizing FAA air traffic control radar data. This makes it possible to match actual flights with noise events.

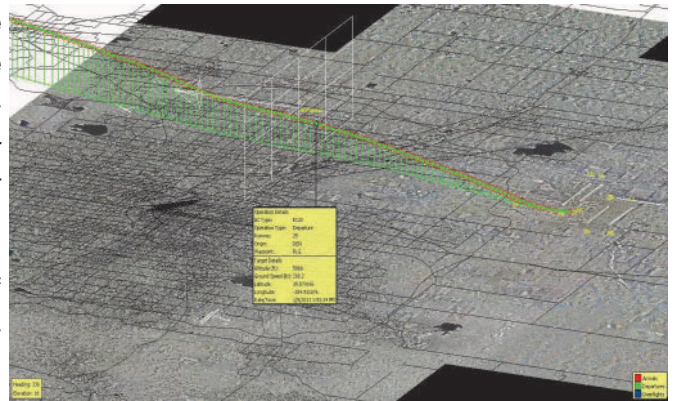

ARTSMAP

ARTSMAP is a specially designed noise modeling program that automatically creates noise contours. ARTSMAP is designed to create contours from actual radar flight tracks that DEN receives from the FAA ARTS system which is sent via modem, eliminating the need for manual data manipulation. The ARTSMAP software is installed on a computer in the DEN Noise Abatement Office. The program analyzes, views, reports, and stores the data.

Currently, ARTSMAP is used at several major airports nationally. It allows the DEN Noise Abatement Office to perform noise data analysis, generate daily automated noise contours, receive detailed runway utilization and perform identification for airline fleet mix.

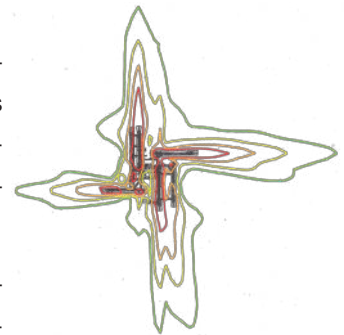

ARTSMAP Output

Land Use and Zoning

Urban growth and development in the areas surrounding DEN, particularly non-compatible residential and other noise-sensitive land uses, is of utmost concern to the City and County of Denver.

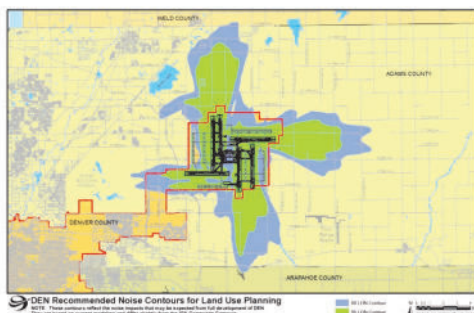

The DEN Noise Abatement Office has developed noise contours surrounding the airport, inside which certain types of land uses are not recommended. The 65 Ldn noise contour (average decibel level with a 10 decibel penalty applied to nighttime operations) is a line inside which, under Federal guidelines, no residential development should occur.

The operational 65 Ldn noise contour for the airport, as created by ARTSMAP, is included in this report. However, for DEN, the 60 Ldn noise contour is used for compatible land use planning by the surrounding jurisdictions, in accordance with guidelines promulgated by the Denver Regional Council of Governments and the Denver/Adams County Intergovernmental Agreement. Additional mapping for DEN that includes the applicable noise contours is available upon request.

DEN Noise Hotline Policy

The purpose of the DEN Noise Complaint Hotline is to provide an opportunity for individuals to express their concerns regarding noise generated by aircraft operating at DEN. Citizens are asked to leave their name, address, and the date and time of their complaint on the hotline. Complaints are downloaded daily by our Noise Officers and then transcribed into the ANOMS system, where specific complaints can be matched to individual flight tracks. It is essential for all information to be entered correctly in order for the system to be effective.



Profanity will not be tolerated, and will result in the complaint not being registered. Any attempt to deliberately tie-up or abuse the Hotline may result in police action. Phone harassment is a state criminal offense and can carry a jail sentence and/or fine. Threats involving aircraft and/or the airport are a very serious matter and are a federal criminal offense. To make a threat, even jokingly, will result in a notification to the Denver Police Department and may involve an FBI investigation.

Glossary of Terms

Sound: A rapid variation in air pressure, which is perceived by the ear and brain as sound.

Noise: Generally considered to be any sound, which is deemed undesirable by an individual.

Decibel: Sound is measured by its pressure or energy in terms of decibels. The decibel scale is logarithmic; when the decibel level increases by 6 dB, the measured sound is twice as loud.

Noise Abatement: A measure or action that minimizes the amount or impact of noise on the environs of an airport. Noise abatement measures include aircraft operating procedures and use or disuse of certain runways or flight tracks. These operating procedures are controlled by the FAA.

A-weighted Sound Level (dBA): A type of sound level measurement which reduces the effect of very high and very low frequencies in order to mimic the response of the human ear. Nearly all aircraft sound level measurement is conducted using A-weighting.

Equivalent Continuous Sound Level (Leq): A measurement of the average sound energy experienced over a period of time. This average sound level is expressed in decibels, and includes a notation of the period of time, which it covers (such as Leq (24) for an average of the sound level over a 24-hour period).

Day Night Level (Ldn): Also referred to as DNL. Similar to a Leq measurement, but is conducted over at least a 24-hour time span and includes a 10dB nighttime penalty. For an Ldn calculation, all noise that occurs at night (defined as 10 p.m. to 7 a.m.) is artificially increased for the public's increased sensitivity to noise during these hours.

Noise Contour: A line surrounding an airport that encloses a geographic region, which is exposed to a particular Ldn level. These contour lines are nested in such a way that contours closer to the airport generally surround areas that experience higher noise levels than contours farther out. Annual Ldn contours are used to determine whether certain types of zoning or land uses are compatible with particular annual Ldn noise levels. 65 Ldn is considered by many federal agencies to be the level at which residential land use becomes incompatible.

Remote Monitoring Terminal (RMT): Consists of a noise level analyzer, a weatherproof microphone, a system controller, a power supply, and a dedicated telephone line to download noise data to the ANOMS system, all mounted in a weatherproof cabinet.



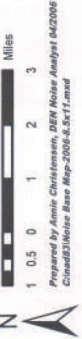
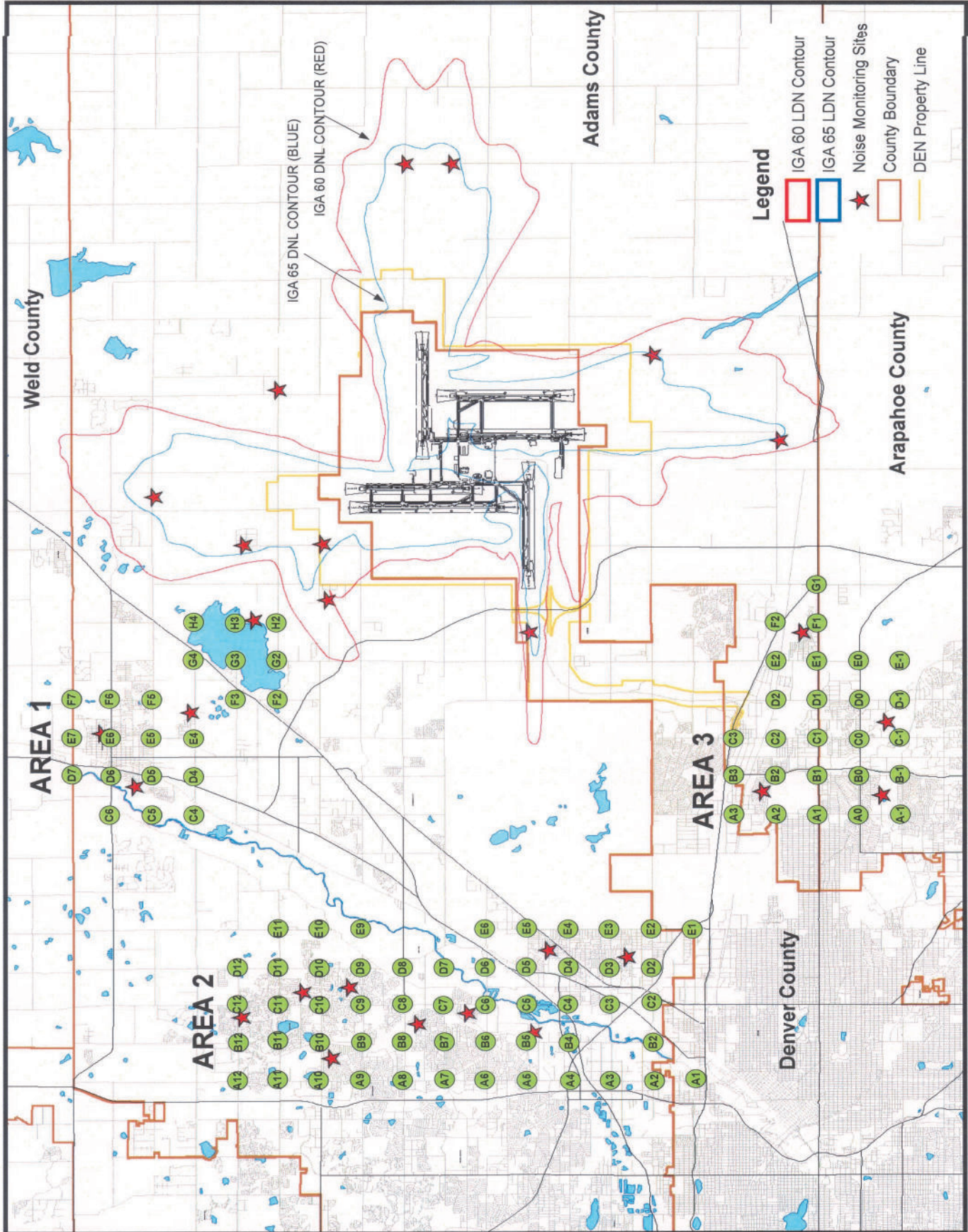

DEN Noise Exposure Points, IGA 60 and 65 LDN Contours, and Noise Monitoring Sites.



Prepared by Annie Christensen, DEN Noise Analyst 04/2006
C:\den\Noise_Base_Map-2006-8.5x11.mxd

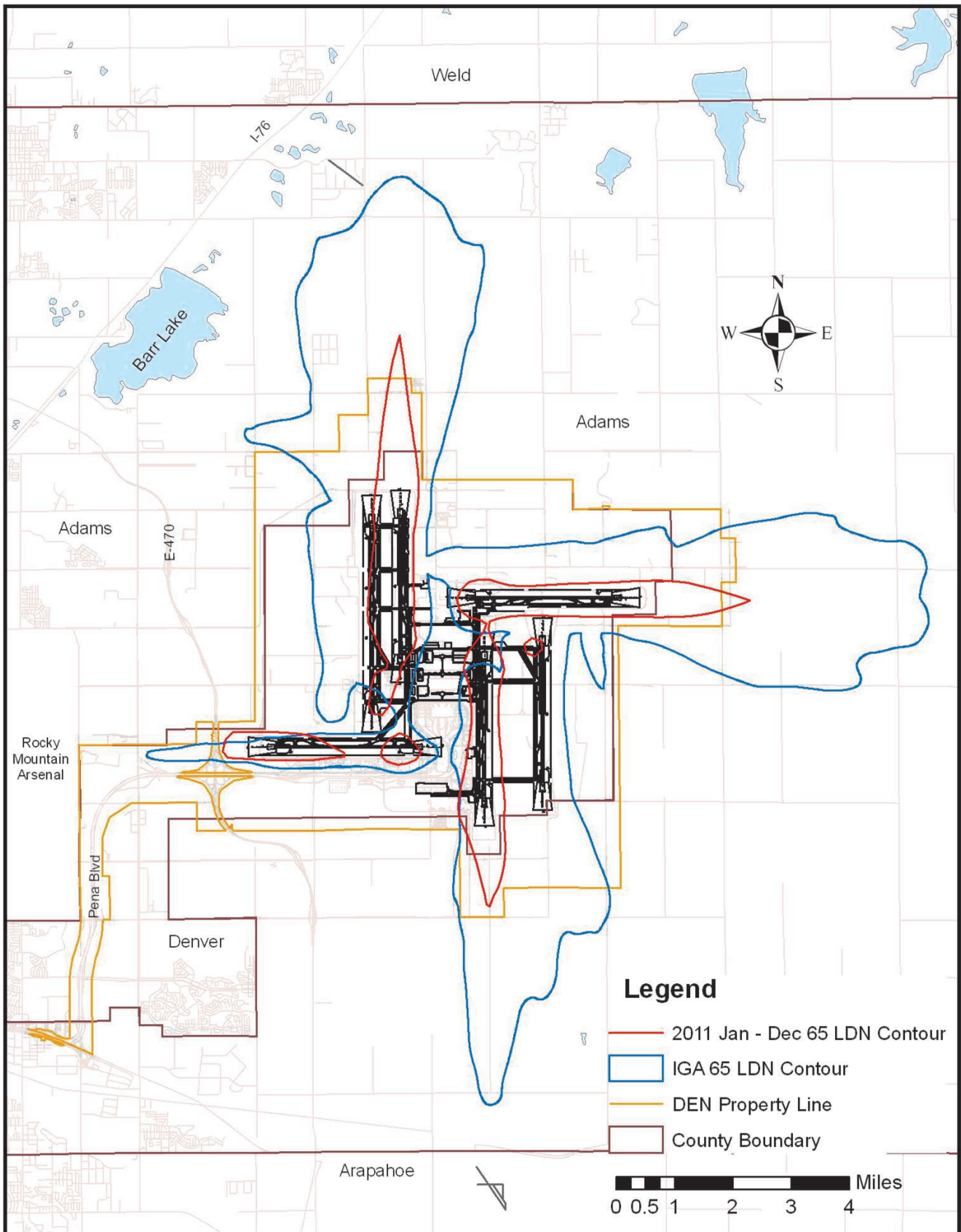

DEN January 1 - December 31, 2011 Contour

Area 2 January 1 through December 31, 2011			
Grid Points	IGA Annual Leq (24)	Calculated Leq (24)	Difference Leq
A,1	38.6	37.0	-1.6
A,2	37.6	37.8	0.2
A,3	42.3	38.6	-3.7
A,4	45.3	39.1	-6.2
A,5	43.9	39.1	-4.8
A,6	37.5	36.7	-0.8
A,7	37.7	36.5	-1.2
A,8	36.5	37.9	1.4
A,9	36.3	39.0	2.7
A,10	37.6	38.1	0.5
A,11	39.2	36.4	-2.8
A,12	41.2	35.2	-6.0
B,2	39.5	38.2	-1.3
B,4	42.5	40.0	-2.5
B,5	43.1	40.2	-2.9
B,6	39.0	37.5	-1.5
B,7	39.0	37.5	-1.5
B,8	38.0	39.3	1.3
B,9	38.3	40.1	1.8
B,10	39.0	38.7	-0.3
B,11	40.4	36.8	-3.6
B,12	42.6	35.9	-6.7
C,2	41.0	38.9	-2.1
C,3	43.3	39.5	-3.8
C,4	43.5	40.9	-2.6
C,5	43.4	41.5	-1.9
C,6	43.3	38.4	-4.9
C,7	43.3	38.5	-4.8
C,8	42.6	40.6	-2.0
C,9	42.2	41.0	-1.2
C,10	41.6	38.9	-2.7
C,11	42.5	36.8	-5.7
C,12	44.3	36.0	-8.3
D,2	41.7	39.8	-1.9
D,3	46.2	40.0	-6.2
D,4	48.4	41.7	-6.7
D,5	48.2	42.8	-5.4
D,6	46.2	39.3	-6.9
D,7	44.2	39.7	-4.5
D,8	43.7	42.1	-1.6
D,9	43.1	41.4	-1.7
D,10	44.9	38.4	-6.5
D,11	44.5	36.5	-8.0
D,12	45.1	35.7	-9.4
E,1	42.4	39.4	-3.0
E,2	42.2	40.9	-1.3
E,3	46.7	40.7	-6.0
E,4	51.2	42.5	-8.7
E,5	51.0	44.3	-6.7
E,6	44.6	40.2	-4.4
E,9	43.1	41.2	-1.9
E,10	43.1	37.7	-5.4
E,11	46.1	36.2	-9.9

Area 1 January 1 through December 31, 2011			
Grid Points	IGA Annual Leq (24)	Calculated Leq (24)	Difference Leq
C,4	44.2	36.6	-7.6
C,5	36.7	34.9	-1.9
C,6	36.0	34.0	-2.0
D,4	41.1	36.0	-5.1
D,5	34.2	34.9	0.7
D,6	36.0	34.7	-1.4
D,7	41.4	35.2	-6.2
E,4	38.3	35.3	-3.0
E,5	34.8	35.1	0.3
E,6	36.7	34.0	-2.7
E,7	41.4	33.8	-7.6
F,2	51.7	39.6	-12.1
F,3	43.7	36.9	-6.8
F,5	37.3	33.6	-3.7
F,6	38.5	33.4	-5.1
F,7	42.1	33.7	-8.5
G,2	51.2	40.5	-10.7
G,3	42.1	36.4	-5.7
G,4	40.2	34.3	-5.9
H,2	50.1	41.2	-8.9
H,3	46.0	36.2	-9.8
H,4	46.1	34.7	-11.4

Area 3 January 1 through December 31, 2011			
Grid Points	IGA Annual Leq (24)	Calculated Leq (24)	Difference Leq
A,-1	38.9	32.7	-6.3
A,0	39.6	32.9	-6.7
A,1	43.2	33.6	-9.6
A,2	45.7	34.7	-11.1
A,3	45.6	36.0	-9.6
B,-1	37.9	32.7	-5.2
B,0	39.2	33.0	-6.2
B,1	42.6	33.5	-9.1
B,2	45.8	34.4	-11.4
B,3	45.7	35.5	-10.2
C,-1	36.7	33.2	-3.5
C,0	37.1	33.2	-3.9
C,1	39.5	33.5	-6.0
C,2	44.8	34.2	-10.6
C,3	46.5	35.1	-11.4
D,-1	32.6	33.3	0.6
D,0	33.3	32.9	-0.4
D,1	37.3	33.0	-4.3
D,2	43.0	33.2	-9.8
E,-1	31.4	33.0	1.6
E,0	33.1	32.3	-0.8
E,1	36.2	32.5	-3.7
E,2	40.6	33.2	-7.4
F,1	36.5	33.2	-3.3
F,2	39.4	34.0	-5.4
G,1	42.5	33.9	-8.6

2011 Noise Complaint Calls by Community*

Community*	No. of Calls 2011	No. of Callers 2011	No. of Calls 2010	No. of Calls 2009
Arvada	2	2	0	0
Aurora	853	9	1122	625
Bennett	19	1	41	22
Boulder	9	2	0	0
Brighton	10	3	177	262
Broomfield	1	1	1	0
Commerce City	76	11	88	139
Denver	17	6	10	32
Elizabeth	91	2	42	126
Hudson	14	2	9	9
Northglenn	6	2	3	4
Parker	14	5	47	28
Strasburg	1144	2	592	369
Thornton	2	1	92	89
Watkins	3	2	78	40
Westminster	27	1	18	7
Overall Total	2293	52	2320	1752

Total Calls by Community

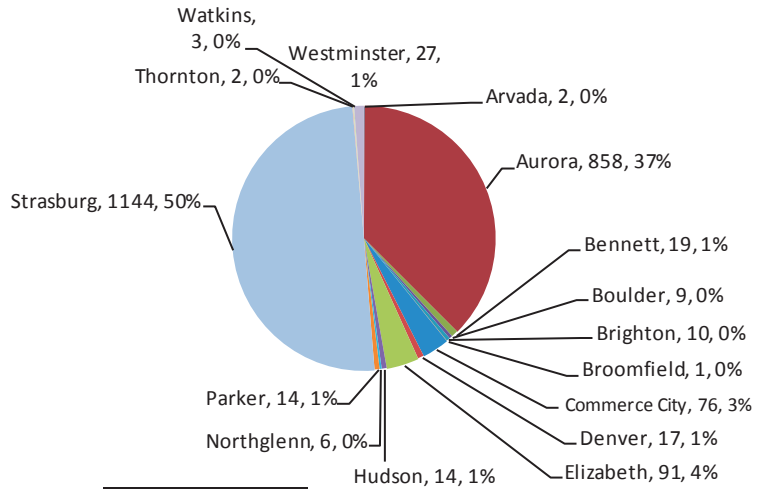

Top 5 Complainants vs. All Others

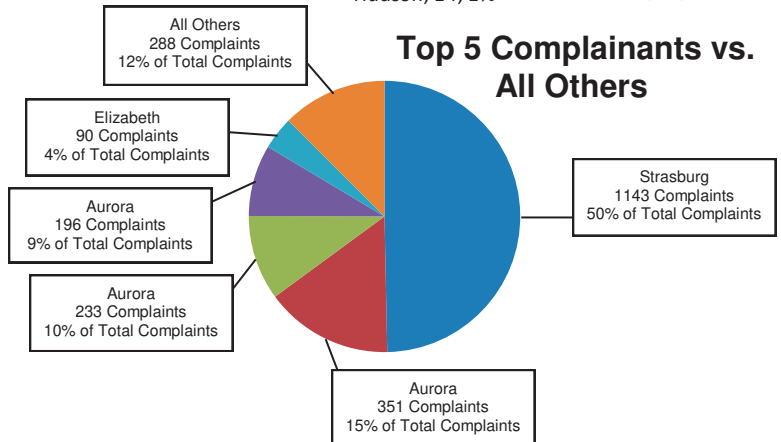

Monthly Comparison: 2011 Noise Complaint Calls - Daytime vs. Nighttime

Time Complaint Received	January	February	March	April	May	June	July	August	September	October	November	December	2011 Total
Day Hours (7:00 am to 9:59 pm)	163	94	229	181	188	165	199	148	188	164	149	116	1984
Night Hours (10:00 pm to 6:59 am)	15	28	27	16	21	17	39	52	25	37	24	8	309
Total	178	122	256	197	209	182	238	200	213	201	173	124	2293

Monthly Comparison: 2010 Total Operations vs. 2011 Total Operations

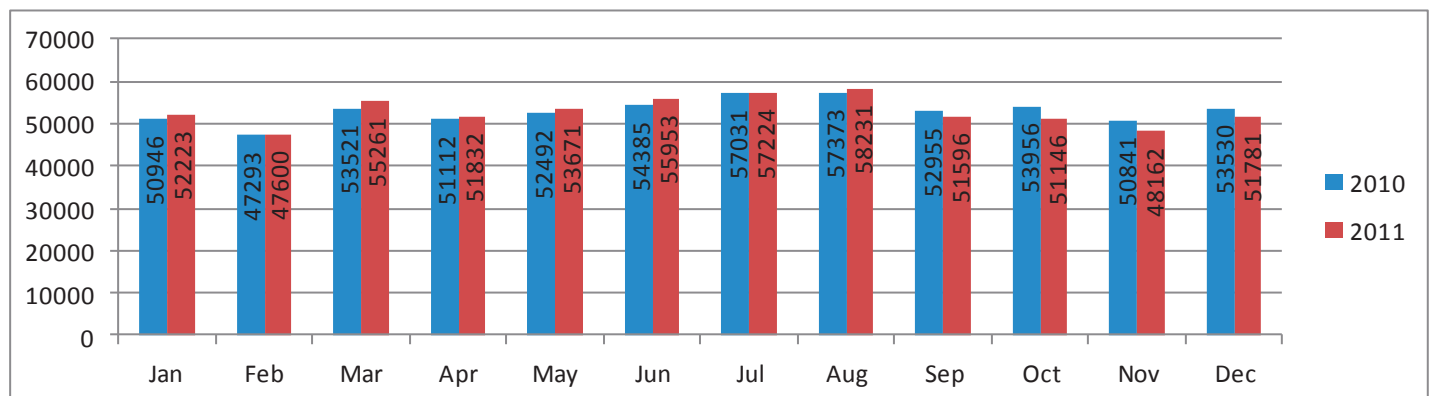

DEN Complaint Location Map

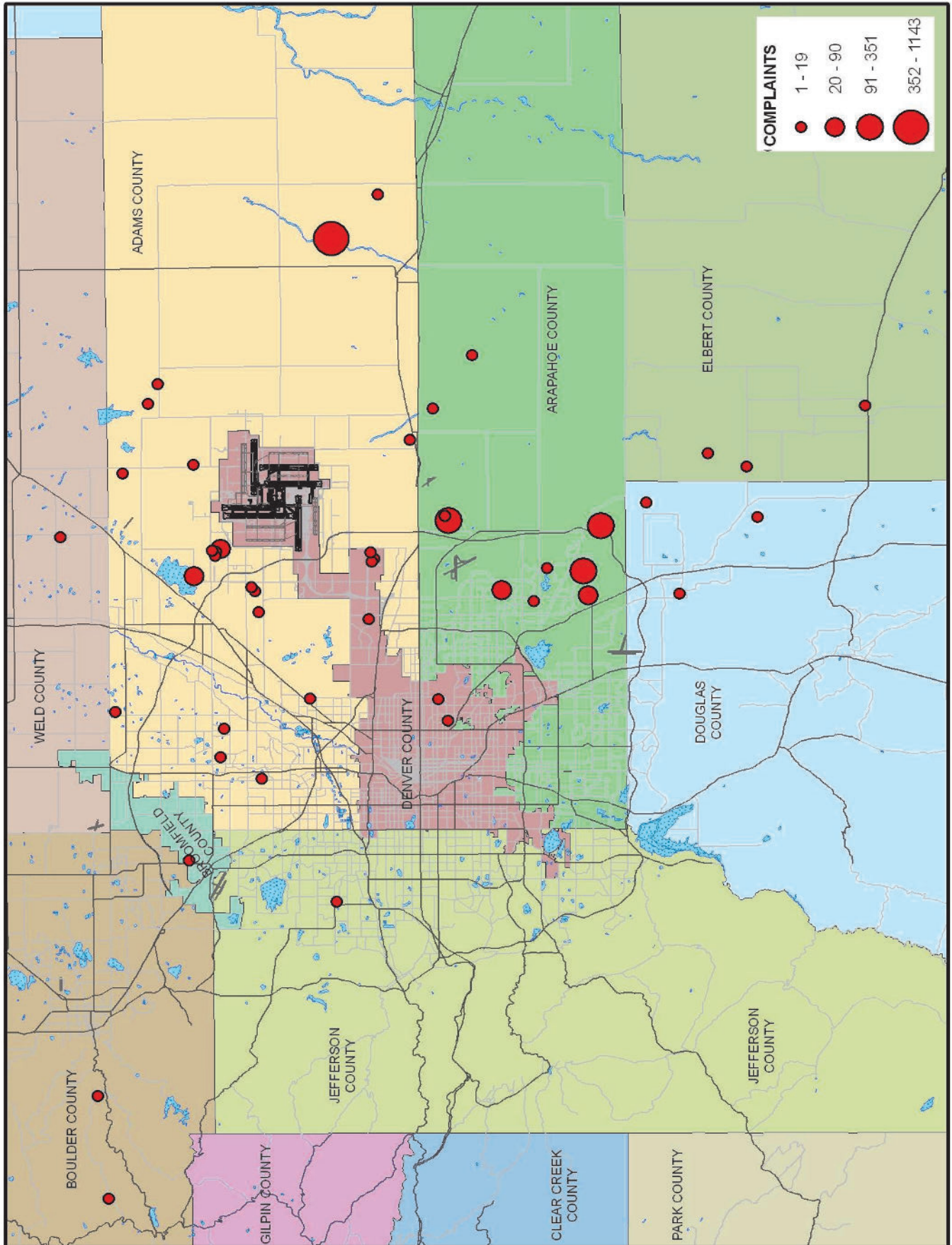

JANUARY 1 - DECEMBER 31, 2011 DEN NOISE COMPLAINTS

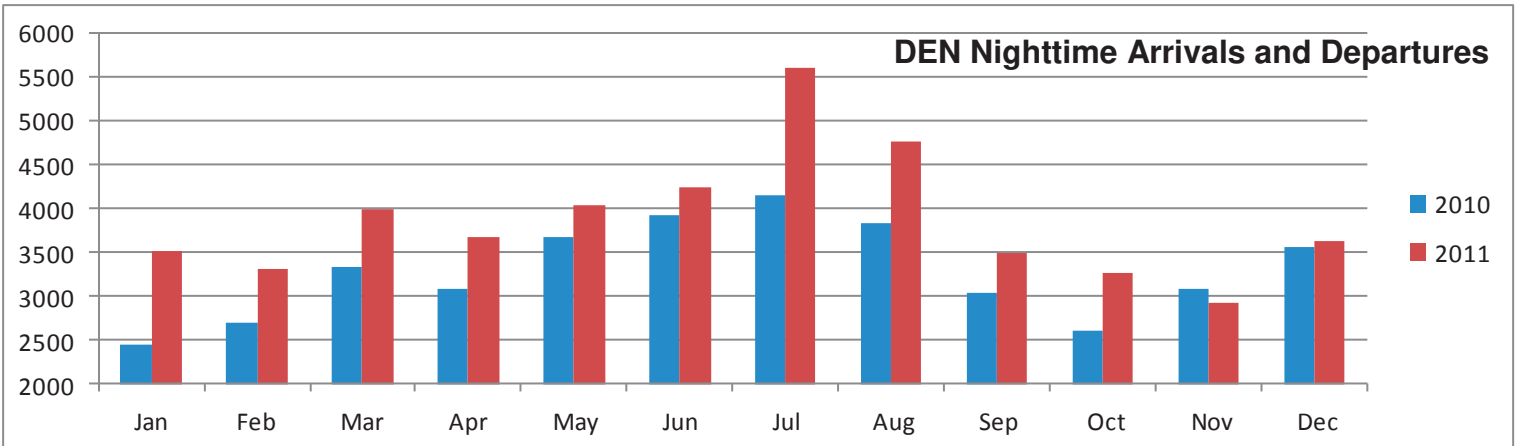
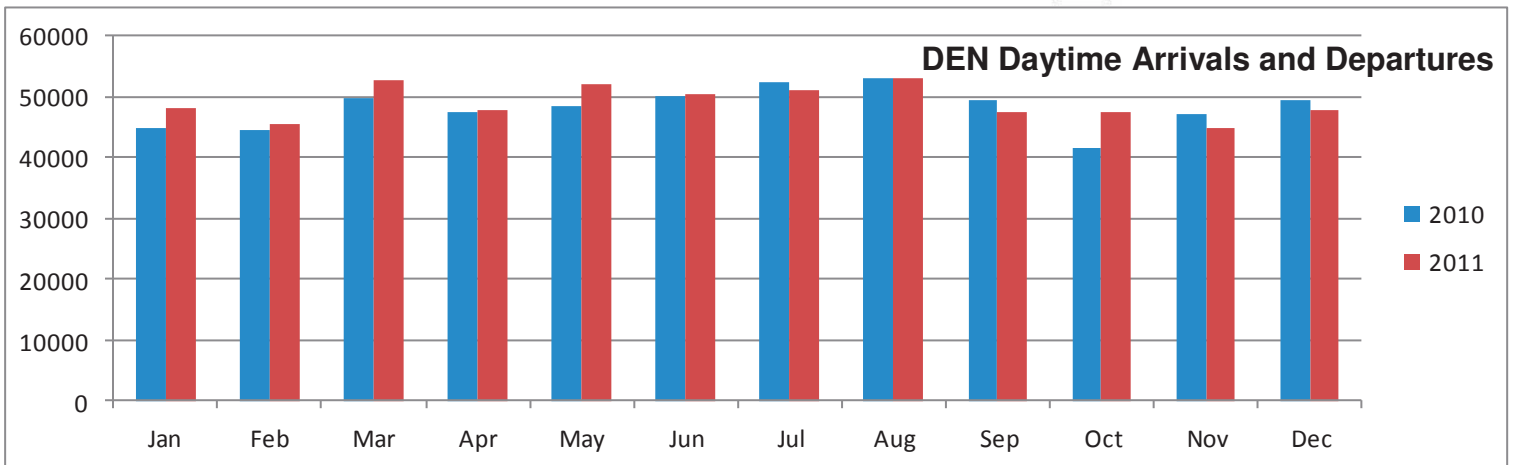
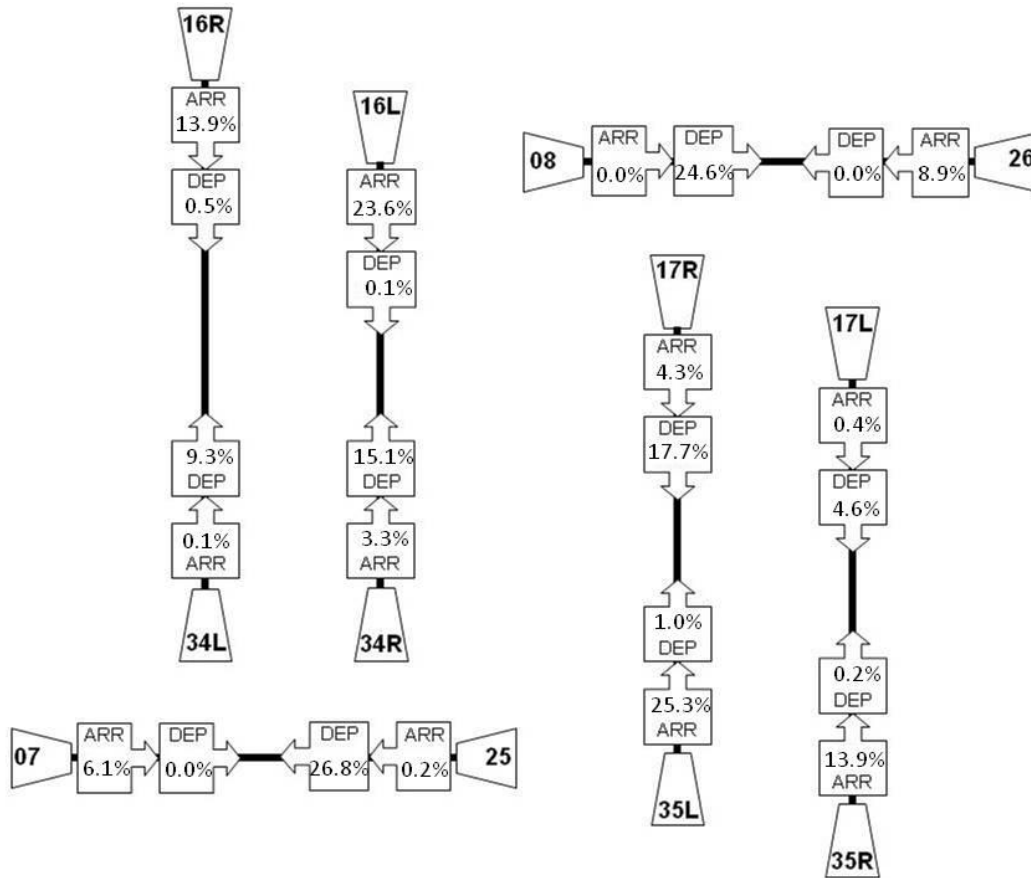



WebTrak Flight Tracking, Noise and Complaint Information System

WebTrak is a system that allows citizens to watch the movement of flights and air traffic patterns within the greater Denver region. This flight tracking system includes specific information about flights from DEN, Centennial Airport (APA), Rocky Mountain Metropolitan Airport (BJC), and Buckley Air Force Base (BKF), as well as information on air traffic transitioning through the

Denver region. Information shown includes the aircraft's type, altitude, origin/destination airports, and flight identification. Visit WebTrak <http://webtrak.bksv.com/den>.

Real time and historical flight data and aircraft radar data originate from the Federal Aviation Administration (FAA) ARTS radar system at the Denver TRACON facility in Denver. The ARTS data is downloaded and processed by DEN's Airport Noise and Operations Monitoring System (ANOMS).

Real time data is viewed in the Live Mode and is delayed approximately 21 minutes for aviation security reasons and for system processing. Noise data from 27 permanent noise monitoring terminals (NMTs) located in the vicinity of DEN are available only in the Replay Mode for the previous day (s). Historical flight and noise data is viewed in the Replay Mode and is available up to 60 days in the past.

NEED MORE INFORMATION?



Visit business.flydenver.com for more information regarding DIA's Noise Abatement Program.

There you will find very helpful information including; FAQs, Annual Reports, land use maps and much more.

DEN Noise Office
AOB, 6th fl, NW Corner
8500 Peña Boulevard
Denver, CO 80249-6340
303.342.2000 ph
303.342.2366 fax
303.342.2380 hotline
800.417.2988 toll free hotline
business.flydenver.com